

FreshAir Flow Control

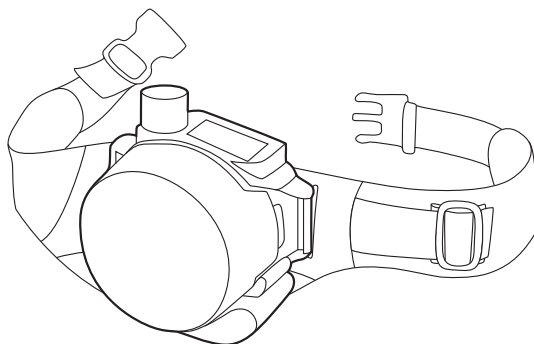

Operating manual **EN**

Brugsanvisning **DA**

Gebrauchsanweisung **DE**

Manual de instrucciones **ES**

Käyttöohje **FI**

Manuel d'utilisation **FR**

Manuale d'uso **IT**

Gebruiksaanwijzing **NL**

Bruksanvisning **NO**

Instrukcja obsługi **PL**

Manual de utilização **PT**

Инструкции по эксплуатации **RU**

Bruksanvisning **SV**

操作手册 **ZH**

OPERATING MANUAL

English

CONTENTS

1.	Introduction	5
1.1	General.....	5
1.2	About FreshAir Flow Control system.....	5
1.3	Manufactured by.....	6
2.	Preconditions for use	6
3.	Unpacking and Assembly	7
3.1	Unpacking.....	7
3.2	Assembly.....	8
4.	Usage	8
4.1	Inspection before every use	8
4.2	Air flow test.....	8
4.3	Using the FreshAir Flow Control.....	8
4.4	Checking the battery state	9
4.5	Checking the filter.....	10
5.	Maintenance.....	10
6.	Spare parts	10
6.1	About the filters.....	10
6.2	Changing the filter	11
6.3	About the batteries	12
6.4	Charging the battery.....	12
6.5	Changing the battery.....	13
7.	Troubleshooting.....	14
8.	Storage	15
9.	Warranty.....	15
10.	Technical data.....	16
11.	Ordering codes.....	17

1. INTRODUCTION

1.1 General

Congratulations on choosing the FreshAir Flow Control respiratory system. Used correctly, Kemppi products can significantly increase the productivity of your welding, and provide years of economical service.

This operating manual contains important information on the use, maintenance and safety of your FreshAir Flow Control respiratory system. The technical specifications of the equipment can be found at the end of the manual.

Please read the operating manual and other instructions carefully before using the equipment for the first time.

For more information on Kemppi products, contact Kemppi Oy, consult an authorised Kemppi dealer, or visit the Kemppi web site at www.kemppi.com.

The specifications presented in this manual are subject to change without prior notice.

Important notes

Items in the manual that require particular attention in order to minimise damage and personal harm are indicated with the *'NOTE!'* notation. Read these sections carefully and follow their instructions.

1.2 About FreshAir Flow Control system

FreshAir is a respiratory protective system, which is based on the principle of circulated pressurized air in the hood. The belt-mounted blower unit delivers air through a filter and via an air hose into a headpiece. The supply of filtered air creates positive pressure inside the headpiece, which prevents the external contaminated air from entering the user's breathing zone.

The supply of air also ensures the user comfortable breathing without having to overcome the resistance of filters.

FreshAir Flow Control respiratory system meets the European standard EN 12941, when used with Beta/Delta 90 FreshAir helmets.

It provides protection against non-toxic and toxic particles, solid and liquid aerosols.

Disclaimer

While every effort has been made to ensure that the information contained in this guide is accurate and complete, no liability can be accepted for any errors or omissions. Kemppi reserves the right to change the specification of the product described at any time without prior notice. Do not copy, record, reproduce or transmit the contents of this guide without prior written permission from Kemppi.

1.3 Manufactured by

Manufactured for and on behalf of Kemppi Oy by:

CleanAir Ltd.

2. PRECONDITIONS FOR USE

FreshAir Flow Control respiratory system can be used for protection against solid and liquid particles in breathing air in welding and similar processes. Do not use it against toxic gases and vapours.

Before you can use the system correctly and safely, you must fully understand all of the following precautions.

- Oxygen concentration in the surrounding area must not drop under 17%.
- Type and concentration of the contaminants in the working place must be known to the user.
- The FreshAir respiratory system must not be used in unventilated areas such as tanks, pipes, channels etc.
- The FreshAir respiratory system must not be used in areas with danger of explosion.
- The respiratory system must only be used with the blower unit switched on.
- The air flow must be checked before use.
- If the blower unit stops working for any reason, the user must leave the contaminated area immediately.
- If the blower unit is switched off, the respiratory system gives little or no respiratory protection. There is also a risk of high concentration of carbon dioxide (CO₂) and of oxygen reduction inside the headpiece.

NOTE! During a period of really hard work when user's breathing becomes very intense, pressure may decrease inside the hood and thus the protective effect can decrease.

- The headpiece must fit the user's face perfectly, only then the efficiency of the system is sufficient. The protective effect of the complete system is reduced, if the seal of the headpiece is not fitted properly, for example, due to beards or long hair breaking the seal.
- It must be ensured that the air hose does not make a loop and does not get caught or trapped in the surroundings.
- Respiratory system FreshAir Flow Control is restricted for protection against solid and liquid particles only. Do not use it against toxic gases and vapours.
- It is essential to choose the correct type of filter according to the type of contamination.
- A particle filter must not be used for protection against gases.
- A gas filter must not be used for protection against particles.

- If the breathing air in the workplace contains both particle and gas contamination, an adequate combined filter must be used.
- When using filters protecting against gases, which are difficult to identify by smell or other senses, special rules depending on the current conditions must be followed.
- Immediately replace the filter(s) as soon as the contaminant can be smelt.
- Use only original filters certified for the particular respiratory system.

NOTE! If the recommendations stated in this manual are ignored, the warranty is automatically invalidated and the level of personal protection may not meet the designated standards.

3. UNPACKING AND ASSEMBLY

3.1 Unpacking

Check that the package is complete and that no part has been damaged in transit or for other reasons.

A package with the complete system including accessories contains:

1.	Blower unit including battery	1 pc
2.	Belt	1 pc
3.	Flexi hose	1 pc
4.	Air flow indicator	1 pc
5.	Battery charger	1 pc
6.	Operating manual	1 pc

The powered unit FreshAir Flow Control is supplied including the filter PSL R.

3.2 Assembly

1. Attach the respiratory unit onto the belt. Make sure that the filter or filters are fitted properly.
2. Connect the air hose to the blower unit via a bayonet connector.
3. Connect the air hose to the headpiece and hand tighten.

4. USAGE

4.1 Inspection before every use

Do the following checks always before you start using the equipment:

- Check that all components are in good condition with no visible damage. Replace any damaged or worn parts. Carefully examine the air hose, seals and the facepiece.
- Check that there is a good connection between the air hose and the headpiece as well as the blower unit
- Ensure that there is sufficient air flow as explained in section "Air flow test".
- Check that the air is supplied through the whole respiratory system from the blower to the hood.

Fully charge the battery before first use.

4.2 Air flow test

Before every use, you should conduct an air flow test on the equipment as follows:

1. Disconnect the air hose from the hood.
2. Cover the disconnected end of the air hose with your hand. The blower starts to run faster after about 20 seconds, the audible alarm activates and the LED diodes on the control panel start blinking.
3. Remove your hand. The blower speed should decrease.

If the blower speed does not change, it is necessary to check the unit.

4.3 Using the FreshAir Flow Control

Switch on the unit by pressing the ON/OFF button on the control panel.



The airflow can be adjusted by plus and minus buttons (+ and -) from 140 l/min up to 210 l/min. The number of lit green LED diodes displays the airflow level.

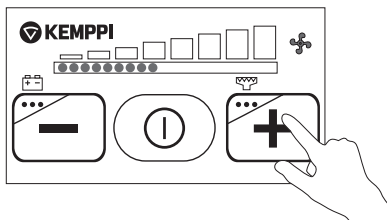

The unit ensures a constant supply of air. The microprocessor inside the unit automatically regulates the motor speed to compensate the filter clogging and the battery state.

If the microprocessor cannot maintain the adjusted airflow, an acoustic alarm signal can be heard and the LED diodes display RED in colour. If possible, the microprocessor automatically reduces the airflow to the next lower level.

When the airflow falls below the minimum level, the alarm intensifies. Then the user must stop working at once and change the filter or recharge/change the battery.

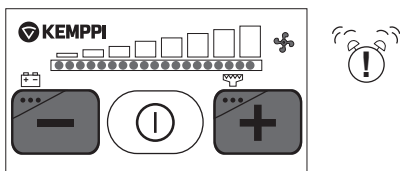

To check the alarm function, perform the air flow test as explained in section 4.2: "Air flow test".

4.4 Checking the battery state

Press and hold the left button (-) for more than 1 second. The more red coloured LED diodes come on, the higher the remaining battery capacity is.

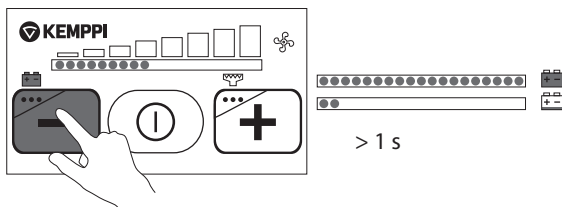

4.5 Checking the filter

Press and hold the right button (+) for more than 1 second. The more yellow LED diodes come on, the more clogged the filter is.

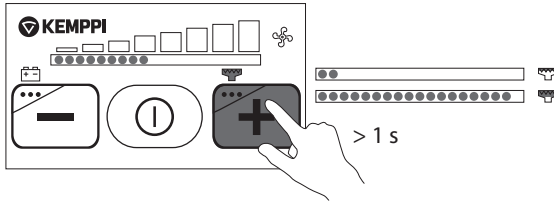

After releasing the buttons, the LED diodes return to the green light state indicating the current airflow.

5. MAINTENANCE

It is recommended to clean the respiratory system after each use. Also inspect all parts and replace any which are damaged or worn.

- Always clean the respiratory unit in a ventilated room or outside. Be aware of harmful dust settled on any parts of the unit.
- Never use flammable cleaning liquids or abrasive cleaners!
- The outer surface of the blower unit can be cleaned with a soft cloth and mild detergent solution. The unit must be completely dry before assembling the filler and cover.
- Ensure that no water or detergents enter the blower unit!
- The air hose itself, detached from the blower unit and the headpiece, can be rinsed in clean water.

6. SPARE PARTS

6.1 About the filters

The respiratory power unit is equipped with a high efficiency particle filter of class PSL R.

The filter must be checked regularly and replaced when necessary. See section 4.2: "Air flow test".

Make sure that the new filter is within its expiry date, unused and not noticeably damaged.

From the hygienic point of view the maximum working time of a filter is 180 hours and should not be exceeded.

Never clean the filter by any procedure!

The particle filter can be used with a Pre-filter to prolong the main filter life, or with an Odor filter which removes unwanted odors.

6.2 Changing the filter

Remove the filter cover:

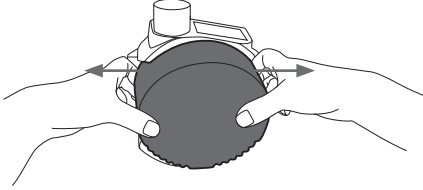

Have the orange filter cover facing you and do the following:

1. Put your index fingers and middle fingers into the gaps between the body of the unit and the filter cover on both sides.
2. Rest your thumbs on the top of the orange filter cover.
3. Pull your fingers placed in the gaps outwards lifting the filter cover off the unit.

NOTE! Never use any tools to uncover the filter.

Remove the filter:

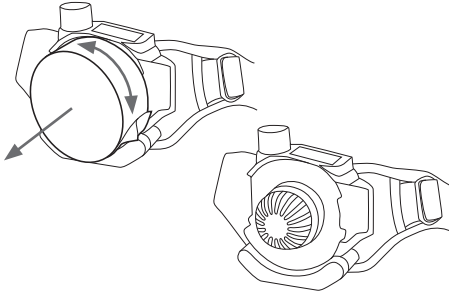

1. Hold, gently rotate and pull away from the main body.
2. Remove any dust with a soft cloth.

Insert a new filter:

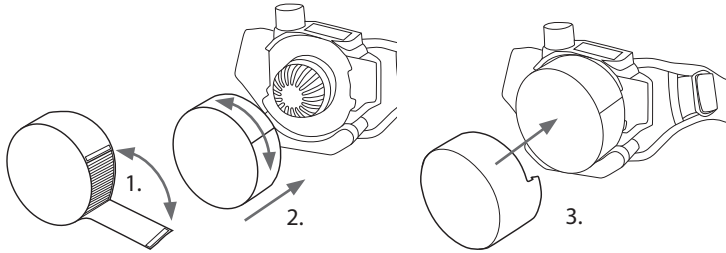

1. If you are using a prefilter or an odor filter, place and fix it around the new filter as tightly as possible, sticking the ends together using the sticky tape located on the ends of the prefilter or odor filter.
2. Put the filter back into position using the same rotating motion and gently push until it fits well onto the body of the unit.
3. Replace the orange filter cover. Ensure you snap the cover into place on both sides.

6.3 About the batteries

NOTE! Batteries are delivered discharged. All batteries must be charged before they are used for the first time. The battery can be charged separately or on the blower unit.

The charger must not be used for any other purpose than that for which it was manufactured. Please read the following precautions:

- Do not charge the battery where there is a risk of explosion.
- The battery charger is intended for indoor use only.
- The charger must be protected against damp.

6.4 Charging the battery

1. Check that the voltage of the electrical power supply is correct.
2. Plug the charger into the socket.
3. Connect the battery to the charger. The socket of the battery is positioned on the back. The charging regime is identified by a red LED diode light.
4. After charging has been completed, the trickle charging regime is activated: red LED diode goes out, the green LED diode comes on at the moment of trickle charging.
5. Disconnect the charger from the power supply.

The charger controls the charging automatically. After the battery has been charged, the charger switches to the trickle charging regime and keeps the battery fully charged. A full charging cycle is between 10 and 14 hours.

NOTE! Do not leave the charger in the power supply if not in use!

6.5 Changing the battery

Remove the battery:

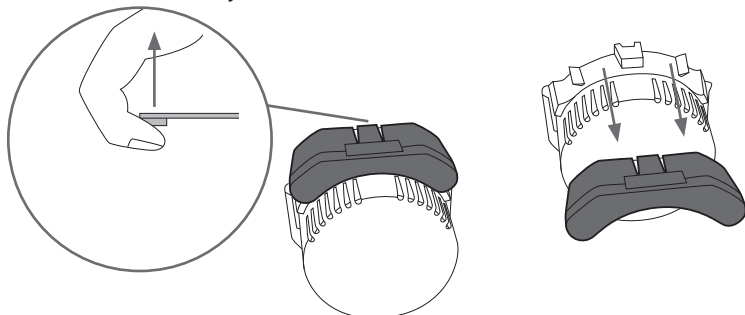

1. Take the blower unit in both hands with the rear side of battery facing you.
2. Open the battery latch with your thumb. The latch is positioned in the middle of the battery.
3. Push the battery off the unit using your thumbs.

Mount the new battery:

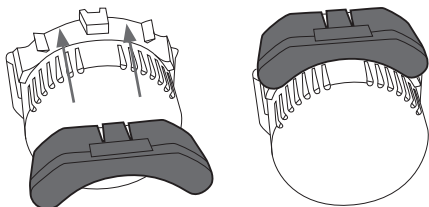

1. Hold the blower unit in the same position as before.
2. Put the battery on the guide rail and push it back onto the unit until the latch locks it in the correct position.

7. TROUBLESHOOTING

If there is a sudden change in air supply while using the FreshAir system, do the following checks:

- Ensure that all parts of the air-supply system are assembled properly.
- Check the battery and its connector.
- Check if the charger is faulty or malfunctioning (if so, the diodes do not work).
- Check the filters and their level of contamination.
- Ensure that there are no holes in the air hose.
- Ensure that the hood seal is correctly fitted and undamaged.
- Check that after a full recharge, the battery holds its charge and the efficiency has not decreased. If so, replace the battery.

Fault	Probable reason	Recommendation
The blower unit does not work at all.	Entirely discharged battery. Verify if the blower unit works with another charged battery.	Charge the battery. If problem persists, replace the battery.
	Faulty motor, circuit board or connector.	Contact your supplier.
Low airflow.	Blocked air hose or airduct.	Check and remove blockage.
	Leakage.	Check all seals, connectors and the air hose. Make sure that air cannot leak through holes or tears.
	Battery is not sufficiently charged.	Charge the battery. If problem persists, replace the battery.
	Blocked Filter.	Change the filter.
Short operating time.	Clogged Filter.	Change the filter.
	Battery is not charged properly.	Charge the battery. If problem persists, replace the battery.
Battery cannot be charged.	Battery contact is damaged.	Replace the battery.
	Charger is faulty.	Contact your supplier.
Battery cannot be charged sufficiently.	Battery is worn out.	Replace the battery.

8. STORAGE

All parts of a FreshAir system must be stored in an environment with temperature between 0 – 40 °C and humidity between 20 – 80 % Rh. The storage life is 2 years for the product if stored in its original unopened package.

NOTE! Batteries get discharged even if not in use. Therefore for long-term storage it is highly recommended to charge the NiMH batteries every 12 months.

9. WARRANTY

There is a 12 month warranty covering production defects and a 6 month warranty for batteries.

The warranty begins from the date of purchase. The claim must be lodged with the dealer. The paid invoice or receipt must be produced if claiming on the warranty.

The claiming procedure will be successful only if there were no changes made on the blower unit including the battery and charger.

If the damage is caused by not changing a clogged filter in time or using a filter which has been cleaned by the customer, the claim will not be processed.

10. TECHNICAL DATA

FreshAir Flow Control	
Airflow	140 – 210 l/min at 8 adjustable flow rates
Weight of the blower unit incl. the filter and battery	900 g
Noise level	55 – 61 dB
NiMh battery lifetime	500 – 700 charging cycles
Charging time	10 – 14 hours
Belt size	80 – 100 cm
Recommended temperature range	10 – 40 °C
Recommended humidity range	20 – 80 % Rh
Certification	EN 12 941 TH2
Operation time	See the following table

Notified body for CE testing:

Výzkumný ústav bezpečnosti práce, v.v.i. – ZL
Testing Laboratory No. 1024
Jeruzalémská 9, 116 52 Praha 1
Authorized Body 235
Notified Body 1024

Expected operating time of the blower unit after being fully charged (hours)

Airflow			Filter
min.	middle	max.	PSL R
X			10 h
	X		6 – 7 h
		X	4 – 5 h

NOTE! Operating time can be decreased where filters are clogged or the battery is undercharged.

11. ORDERING CODES

Beta 90 FreshAir with Flow Control	(9873065 + W007513)	P1700
Delta 90 FreshAir with Flow Control	(9873066 + W007513)	P1701
FreshAir Flow Control with Alarm	Complete package	W007512
Spare parts and consumables		
FA Battery charger	Euro plug	W007485
FA Flow Control Flexi hose		W007487
FA Flow Control Flow indicator		W007488
FA Comfort belt		W007489
FA Basic filter	2 pcs, standard	W007490
FA Flow Control Sealing ring	for filter	W007491
FA Flow Control pre-filter	10 pcs	W007492
FA Battery pack	NIMH 4.8 V/4.5 AH	W007493
FA Basic odour pre-filter	10 pcs	W007494
FA Flow Control Filter cover		W007495
Optional		
FA Flexi hose cover		W007788
FA Heavy duty comfort belt		W007789
FA Head cover		W007827
FA Protective neck cover		W007828

KEMPPI OY

Kempinkatu 1
PL 13
FI-15801 LAHTI
FINLAND
Tel +358 3 899 11
Telefax +358 3 899 428
export@kemppi.com
www.kemppi.com

Kotimaan myynti:

Tel +358 3 899 11
Telefax +358 3 734 8398
myynti.fi@kemppi.com

KEMPPI SVERIGE AB

Box 717
S-194 27 UPPLANDS VÄSBY
SVERIGE
Tel +46 8 590 783 00
Telefax +46 8 590 823 94
sales.se@kemppi.com

KEMPPI NORGE A/S

Postboks 2151, Postterminalen
N-3103 TØNSBERG
NORGE
Tel +47 33 346000
Telefax +47 33 346010
sales.no@kemppi.com

KEMPPI DANMARK A/S

Literbuen 11
DK-2740 SKOVLENDE
DANMARK
Tel +45 4494 1677
Telefax +45 4494 1536
sales.dk@kemppi.com

KEMPPI BENELUX B.V.

Postbus 5603
NL-4801 EA BREDA
NEDERLAND
Tel +31 765717750
Telefax +31 765716345
sales.nl@kemppi.com

KEMPPI (UK) Ltd

Martti Kemppi Building
Fraser Road
Priory Business Park
BEDFORD, MK44 3WH
UNITED KINGDOM
Tel +44 (0)845 6444201
Telefax +44 (0)845 6444202
sales.uk@kemppi.com

KEMPPI FRANCE S.A.S.

65 Avenue de la Couronne des Prés
78681 EPONE CEDEX
FRANCE
Tel +33 1 30 90 04 40
Telefax +33 1 30 90 04 45
sales.fr@kemppi.com

KEMPPI GmbH

Perchstetten 10
D-35428 Langgöns
DEUTSCHLAND
Tel +49 6 403 7792 0
Telefax +49 6 403 779 79 74
sales.de@kemppi.com

KEMPPI SPÓŁKA Z O.O.

Ul. Borzymowska 32
03-565 WARSZAWA
POLAND
Tel +48 22 7816162
Telefax +48 22 7816505
info.pl@kemppi.com

KEMPPI AUSTRALIA PTY LTD.

13 Cullen Place
P.O. Box 5256, Greystanes NSW 2145
SMITHFIELD NSW 2164
AUSTRALIA
Tel. +61 2 9605 9500
Telefax +61 2 9605 5999
info.au@kemppi.com

OOO KEMPPI

Polkovaya str. 1, Building 6
127018 MOSCOW
RUSSIA
Tel +7 495 739 4304
Telefax +7 495 739 4305
info.ru@kemppi.com

ООО КЕМППИ

ул. Полковая 1, строение 6
127018 Москва
Tel +7 495 739 4304
Telefax +7 495 739 4305
info.ru@kemppi.com

KEMPPI, TRADING (BEIJING) COMPANY, LIMITED

Room 420, 3 Zone, Building B,
No.12 Hongda North Street,
Beijing Economic Development Zone,
100176 Beijing
CHINA
Tel +86-10-6787 6064
+86-10-6787 1282
Telefax +86-10-6787 5259
sales.cn@kemppi.com

肯倍贸易 (北京) 有限公司
中国北京经济技术开发区宏达
北路12号

创新大厦B座三区420室 (100176)

电话 : +86-10-6787 6064
+86-10-6787 1282

传真 : +86-10-6787 5259
sales.cn@kemppi.com

KEMPPI INDIA PVT LTD

LAKSHMI TOWERS
New No. 2/770,
First Main Road,
Kazura Garden,
Neelankarai,
CHENNAI - 600 041
TAMIL NADU
Tel +91-44-4567 1200
Telefax +91-44-4567 1234
sales.india@kemppi.com